













| | | |
|--------|----------------------------|--|
| Group: | ME Starters | Notes: Refer to SP1012 -DWG for major component drawing. Refer to TSB-3010 for hardware kit breakdown. |
| Form: | SP1012 | |
| Date: | July 7, 2017 | |
| File: | Starter Parts List Section | |

| Component View | Solenoid Assembly | Drive Assembly | Brushholder Assembly | C.E. Housing Assembly | Shift Housing Assembly | Armature Assembly |
|----------------|---|---|---|--|---|---|
| |  |  |  |  |  |  |
| Model | 1 | 2 | 3 | 4 | 5 | 6 |
| M0017072ME | S214078354S | 852957S | M008102584S | M011102559S | M777102569S | M002102564S |
| M0017073ME | S214078354S | 852957S | M008102584S | M011102559S | M777102569S | M002102564S |
| M0017074ME | S214078354S | 852957S | M008102584S | M011102559S | M777102569S | M002102564S |
| M0017075ME | S214078354S | 852957S | M008102584S | M011102559S | M777102569S | M002102564S |
| M0017260ME | S214078354S | 852959S | M008225160S | M011102559S | M777102569S | M002102564S |
| M0017261ME | S214078354S | 852959S | M008225160S | M011102559S | M777102569S | M002102564S |
| M0017262ME | S214077510S | 852959S | M008225160S | M011102559S | M777102569S | M002225330S |
| M0017264ME | S214078354S | M029013539S | M008102584S | M011102559S | M777102569S | M002102564S |
| M0017265ME | S214077510S | 852959S | M008102584S | M011102559S | M777102569S | M002225330S |
| M0017266ME | S214077510S | 852959S | M008225160S | M011102559S | M777102569S | M002225330S |
| M0017267ME | S214077510S | 852959S | M008225160S | M011102559S | M777102569S | M002225330S |
| M0017268ME | S214077510S | 852959S | M008225160S | M011102559S | M777102569S | M002225330S |
| M0017276ME | S214077510S | 852957S | M008225160S | M011102559S | M777102569S | M002225330S |
| M0017280ME | S214077510S | 852957S | M008225160S | M011102559S | M777102569S | M002225330S |
| M0017281ME | S214077510S | 852957S | M008225160S | M011102559S | M777102569S | M002225330S |
| M0017289ME | S214077510S | 852959S | M008225160S | M011102559S | M777102569S | M002225330S |
| M0017295ME | S214077510S | 852959S | M008225160S | M011102559S | M777102569S | M002225330S |
| M0017296ME | S214078354S | M029013539S | M008102584S | M011102559S | M777102569S | M002102564S |
| M0017297ME | S214078354S | 852959S | M008225160S | M011102559S | M777102569S | M002225330S |
| M0017298ME | S214077510S | 852957S | M008225160S | M011102559S | M777102569S | M002225330S |
| M0017324ME | S214077510S | 852959S | M008225160S | M011102559S | M777102569S | M002225330S |
| M0017325ME | S214077510S | 852959S | M008225160S | M011102559S | M777102569S | M002225330S |
| M0017400ME | S214078354S | 852959S | M008103330s | M011102559S | M777102569S | M002102564S |
| M0017401ME | S214078354S | 852959S | M008225160S | M011102559S | M777102569S | M002102564S |
| M0017406MEC | S214078354S | 852959S | M008225160S | M011102559S | M777102569S | M002102564S |
| M0017406ME | S214078354S | 852959S | M008225160S | M011102559S | M777102569S | M002102564S |
| M0017407ME | S214078354S | 852959S | M008225160S | M011102559S | M777102569S | M002102564S |
| M0017422ME | S214078354S | 852957S | M008225160S | M011102559S | M777102569S | M002102564S |







Important: The information contained in this bulletin is intended for use by trained, professional technicians who have the proper tools, equipment, and training to perform the required maintenance described above. This information is NOT intended for 'do-it-yourselfers', and you should not assume that this information applies to your equipment. If you have any questions regarding this information please visit our website at www.prestolite.com, or contact our technical service department at:

| | | |
|--------|----------------------------|--|
| Group: | ME Starters | Notes: Refer to SP1012 -DWG for major component drawing. Refer to TSB-3010 for hardware kit breakdown. |
| Form: | SP1012 | |
| Date: | July 7, 2017 | |
| File: | Starter Parts List Section | |

| Component View | Solenoid Assembly | Drive Assembly | Brushholder Assembly | C.E. Housing Assembly | Shift Housing Assembly | Armature Assembly |
|----------------|---|---|---|--|---|---|
| |  |  |  |  |  |  |
| Model | 1 | 2 | 3 | 4 | 5 | 6 |
| M0017424ME | S214078354S | 852959S | M008225160S | M011102559S | M777102569S | M002102564S |
| M0017500ME | S214078354S | 852959S | M008225160S | M011102559S | M777102569S | M002225333S |
| M0017504ME | S214078354S | 852959S | M008225160S | M011102559S | M777102569S | M002225333S |
| M0017505ME | S214078354S | 852959S | M008225160S | M011102559S | M777102569S | M002225333S |
| M0017506ME | S214078354S | 852959S | M008225160S | M011102559S | M777102569S | M002225333S |
| M0017507ME | S214078354S | 852959S | M008103330S | M011102559S | M777102569S | M002225333S |
| M0017508ME | S214078354S | 852959S | M008225160S | M011102559S | M777102569S | M002225333S |
| M0017511ME | S214078354S | 852959S | M008225160S | M011225152S | M777102546S | M002225333S |
| M0017512ME | S214078354S | 852959S | M008225160S | M011105559S | M777102569S | M002225333S |
| M0017514ME | S214078354S | 852959S | M008102584S | M011225152S | M777095973S | M002225333S |
| M0017516ME | S214078354S | 852959S | M008225160S | M011105559S | M777102569S | M002225333S |
| M0017517ME | S214078354S | 852959S | M008225160S | M011105559S | M777102569S | M002225333S |
| M0017518ME | S214104598S | 852957S | M008225160S | M011105559S | M777102569S | M002225333S |
| M0017520ME | S214104598S | 852957S | M008225160S | M011105559S | M777102569S | M002225333S |
| M0017600ME | S214077510S | 852959S | M008225160S | M011105559S | M777102569S | M002225334S |
| M0017601ME | S214077510S | 852959S | M008225160S | M011105559S | M777102569S | M002225334S |
| M0017702ME | S214078354S | 852957S | M008102584S | M011225152S | M777225321S | M002102564S |
| M0017703ME | S214078354S | 852957S | M008225372S | M011102559S | M777102554S | M002102564S |
| M0017704ME | S214078354S | PD-11AS | M008102584S | M011102559S | M777102569S | M002225385S |
| M0017705ME | S214078354S | 852957S | M008225396S | M011102559S | M777102554S | M002102564S |
| M0017730ME | S214078354S | 852957S | M008225160S | M011102559S | M777102569S | M002102564S |
| M0017731ME | S214078354S | 852957S | M008225160S | M011102559S | M777102569S | M002102564S |
| M0018268PA | S214077510S | 852959S | M008225160S | M011225152S | M777102569S | M002225330S |
| M0018268TP | S214077510S | 852959S | M008225160S | M011225152S | M777102569S | M002225330S |



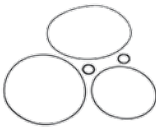

Important: The information contained in this bulletin is intended for use by trained, professional technicians who have the proper tools, equipment, and training to perform the required maintenance described above. This information is NOT intended for 'do-it-yourselfers', and you should not assume that this information applies to your equipment. If you have any questions regarding this information please visit our website at www.prestolite.com, or contact our technical service department at:

| | | |
|--------|----------------------------|--|
| Group: | ME Starters | Notes: Refer to SP1012 -DWG for major component drawing. Refer to TSB-3010 for hardware kit breakdown. |
| Form: | SP1012 | |
| Date: | July 7, 2017 | |
| File: | Starter Parts List Section | |

| Component View | Field and Frame Assembly | Nose Housing Assembly | Hardware Assembly | Brushes Kit | O-Ring Kit | Shift Lever Housing Kit |
|----------------|---|---|---|---|---|---|
| |  |  |  |  |  |  |
| Model | 7 | 8 | 9 | 10 | 11 | 12 |
| M0017072ME | M016225369S | M014102590S | K212104624S | K185104782S | K185104623S | K185104626S |
| M0017073ME | M016225369S | M014225021S | K212104624S | K185104782S | K185104623S | K185104626S |
| M0017074ME | M016225369S | M014225021S | K212104624S | K185104782S | K185104623S | K185104626S |
| M0017075ME | M016225369S | M014102597S | K212104624S | K185104782S | K185104623S | K185104626S |
| M0017260ME | M016225369S | M014102590S | K212104624S | K185104782S | K185104623S | K185104626S |
| M0017261ME | M016225369S | M014102589S | K212104624S | K185104782S | K185104623S | K185104626S |
| M0017262ME | M016225135S | M014225021S | K212104624S | K185104782S | K185104623S | K185104626S |
| M0017264ME | M016225369S | M014102589S | K212104624S | K185104782S | K185104623S | K185104626S |
| M0017265ME | M016225135S | M014225021S | K212104624S | K185104782S | K185104623S | K185104626S |
| M0017266ME | M016225135S | M014225021S | K212104624S | K185104782S | K185104623S | K185104626S |
| M0017267ME | M016225135S | M014102594S | K212104624S | K185104782S | K185104623S | K185104626S |
| M0017268ME | M016225135S | M014102594S | K212104624S | K185104782S | K185104623S | K185104626S |
| M0017276ME | M016225135S | M014225018S | K212104624S | K185104782S | K185104623S | K185104626S |
| M0017280ME | M016225135S | M014225033S | K212104624S | K185104782S | K185104623S | K185104626S |
| M0017281ME | M016225135S | M014225033S | K212104624S | K185104782S | K185104623S | K185104626S |
| M0017289ME | M016225135S | M014225021S | K212104624S | K185104782S | K185104623S | K185104626S |
| M0017295ME | M016225135S | M014225021S | K212104624S | K185104782S | K185104623S | K185104626S |
| M0017296ME | M016225369S | M014102576S | K212104624S | K185104782S | K185104623S | K185104626S |
| M0017297ME | M016225135S | M014225021S | K212104624S | K185104782S | K185104623S | K185104626S |
| M0017298ME | M016225135S | M014103902S | K212104624S | K185104782S | K185104623S | K185104626S |
| M0017324ME | M016225135S | M014225119S | K212104624S | K185104782S | K185104623S | K185104626S |
| M0017325ME | M016225135S | M014225119S | K212104624S | K185104782S | K185104623S | K185104626S |
| M0017400ME | M016102516S | M014102594S | K212104624S | K185104782S | K185104623S | K185104626S |
| M0017401ME | M016102516S | M014225020S | K212104624S | K185104782S | K185104623S | K185104626S |
| M0017406MEC | M016102516S | M014225020S | K212104624S | K185104782S | K185104623S | K185104626S |
| M0017406ME | M016102516S | M014225020S | K212104624S | K185104782S | K185104623S | K185104626S |
| M0017407ME | M016102516S | M014225021S | K212104624S | K185104782S | K185104623S | K185104626S |
| M0017422ME | M016079392S | M014225033S | K212104624S | K185104782S | K185104623S | K185104626S |

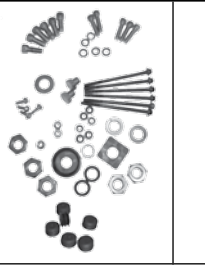
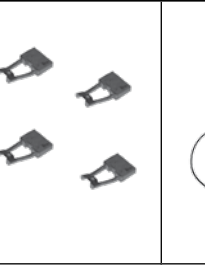
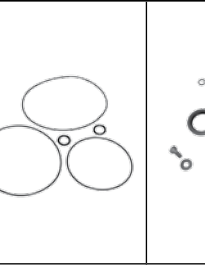

Important: The information contained in this bulletin is intended for use by trained, professional technicians who have the proper tools, equipment, and training to perform the required maintenance described above. This information is NOT intended for 'do-it-yourselfers', and you should not assume that this information applies to your equipment. If you have any questions regarding this information please visit our website at www.prestolite.com, or contact our technical service department at:



| | | |
|--------|----------------------------|--|
| Group: | ME Starters | Notes: Refer to SP1012 -DWG for major component drawing. Refer to TSB-3010 for hardware kit breakdown. |
| Form: | SP1012 | |
| Date: | July 7, 2017 | |
| File: | Starter Parts List Section | |

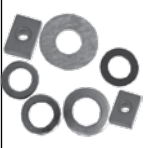

| Component View | Field and Frame Assembly | Nose Housing Assembly | Hardware Assembly | Brushes Kit | O-Ring Kit | Shift Lever Housing Kit |
|----------------|---|---|---|--|---|---|
| |  |  |  |  |  |  |
| Model | 7 | 8 | 9 | 10 | 11 | 12 |
| M0017424ME | M016102516S | M014225119S | K212104624S | K185104782S | K185104623S | K185104626S |
| M0017500ME | M016102531S | M014102594S | K212104624S | K185104782S | K185104623S | K185104626S |
| M0017504ME | M016102531S | M014225021S | K212104624S | K185104782S | K185104623S | K185104626S |
| M0017505ME | M016102531S | M014102592S | K212104624S | K185104782S | K185104623S | K185104626S |
| M0017506ME | M016102531S | M014102582S | K212104624S | K185104782S | K185104623S | K185104626S |
| M0017507ME | M016102531S | M014102592S | K212104624S | K185104782S | K185104623S | K185104626S |
| M0017508ME | M016102531S | M014102582S | K212104624S | K185104782S | K185104623S | K185104626S |
| M0017511ME | M016102531S | M014225021S | K212104624S | K185104782S | K185104623S | K185104626S |
| M0017512ME | M016102531S | M014102592S | K212104624S | K185104782S | K185104623S | K185104626S |
| M0017514ME | M016102531S | M014102582S | K212104624S | K185104782S | K185104623S | K185104626S |
| M0017516ME | M016102531S | M014102598S | K212104624S | K185104782S | K185104623S | K185104626S |
| M0017517ME | M016102531S | M014102598S | K212104624S | K185104782S | K185104623S | K185104626S |
| M0017518ME | M016102531S | M014102598S | K212104624S | K185104782S | K185104623S | K185104626S |
| M0017520ME | M016102531S | M014102597S | K212104624S | K185104782S | K185104623S | K185104626S |
| M0017600ME | M016225277S | M014102594S | K212104624S | K185104782S | K185104623S | K185104626S |
| M0017601ME | M016225277S | M014225020S | K212104624S | K185104782S | K185104623S | K185104626S |
| M0017702ME | M016225369S | M014225318S | K212104624S | K185104782S | K185104623S | K185104626S |
| M0017703ME | M016225369S | M014102566S | K212104624S | K185104782S | K185104623S | K185104626S |
| M0017704ME | M016225407S | M014225021S | K212104624S | K185104782S | K185104623S | K185104626S |
| M0017705ME | M016225369S | M014102566S | K212104624S | K185104782S | K185104623S | K185104626S |
| M0017730ME | M016225369S | M014103902S | K212104624S | K185104782S | K185104623S | K185104626S |
| M0017731ME | M016225369S | M014103902S | K212104624S | K185104782S | K185104623S | K185104626S |
| M0018268PA | M016225135S | M014102594S | K212104624S | K185104782S | K185104623S | K185104626S |
| M0018268TP | M016225135S | M014102594S | K212104624S | K185104782S | K185104623S | K185104626S |

Important: The information contained in this bulletin is intended for use by trained, professional technicians who have the proper tools, equipment, and training to perform the required maintenance described above. This information is NOT intended for 'do-it-yourselfers', and you should not assume that this information applies to your equipment. If you have any questions regarding this information please visit our website at www.prestolite.com, or contact our technical service department at:

| | | |
|--------|----------------------------|--|
| Group: | ME Starters | Notes: Refer to SP1012 -DWG for major component drawing. Refer to TSB-3010 for hardware kit breakdown. |
| Form: | SP1012 | |
| Date: | July 7, 2017 | |
| File: | Starter Parts List Section | |

| Component View | Drive / Thrust Washer Kit | Jumper |
|----------------|---|---|
| |  |  |
| Model | 13 | 14 |
| M0017072ME | K185104622S | M047078138S |
| M0017073ME | K185104622S | M047078138S |
| M0017074ME | K185104622S | M047078138S |
| M0017075ME | K185104622S | M047078138S |
| M0017260ME | K185104622S | M047078138S |
| M0017261ME | K185104622S | M047078138S |
| M0017262ME | K185104622S | M047078138S |
| M0017264ME | K185104622S | M047078138S |
| M0017265ME | K185104622S | M047078138S |
| M0017266ME | K185104622S | M047078138S |
| M0017267ME | K185104622S | M047078138S |
| M0017268ME | K185104622S | M047078138S |
| M0017276ME | K185104622S | M047078138S |
| M0017280ME | K185104622S | M047078138S |
| M0017281ME | K185104622S | M047078138S |
| M0017289ME | K185104622S | M047078138S |
| M0017295ME | K185104622S | M047078138S |
| M0017296ME | K185104622S | M047078138S |
| M0017297ME | K185104622S | M047078138S |
| M0017298ME | K185104622S | M047078138S |
| M0017324ME | K185104622S | M047078138S |
| M0017325ME | K185104622S | M047078138S |
| M0017400ME | K185104622S | M047078138S |
| M0017401ME | K185104622S | M047078138S |
| M0017406MEC | K185104622S | M047078138S |
| M0017406ME | K185104622S | M047078138S |
| M0017407ME | K185104622S | M047078138S |
| M0017422ME | K185104622S | M047078138S |

| Component View | Drive / Thrust Washer Kit | Jumper |
|----------------|---|---|
| |  |  |
| Model | 13 | 14 |
| M0017424ME | K185104622S | M047078138S |
| M0017500ME | K185104622S | M047079333S |
| M0017504ME | K185104622S | M047079333S |
| M0017505ME | K185104622S | M047079333S |
| M0017506ME | K185104622S | M047079333S |
| M0017507ME | K185104622S | M047079333S |
| M0017508ME | K185104622S | M047079333S |
| M0017511ME | K185104622S | M047079333S |
| M0017512ME | K185104622S | M047079333S |
| M0017514ME | K185104622S | M047079333S |
| M0017516ME | K185104622S | M047079333S |
| M0017517ME | K185104622S | M047079333S |
| M0017518ME | K185104622S | M047079333S |
| M0017520ME | K185104622S | M047079333S |
| M0017600ME | K185104622S | M047079333S |
| M0017601ME | K185104622S | M047079333S |
| M0017702ME | K185104622S | M047078138S |
| M0017703ME | K185104622S | M047078138S |
| M0017704ME | K185104622S | M047078138S |
| M0017705ME | K185104622S | M047078138S |
| M0017730ME | K185104622S | M047078138S |
| M0017731ME | K185104622S | M047078138S |
| M0018268PA | K185104622S | M047078138S |
| M0018268TP | K185104622S | M047078138S |

| Component View | Hardware- Stainless Steel | Helper Relay and Bracket Kit |
|----------------|---|---|
| |  |  |
| Model | | 15 |
| M0017704ME | K212104599S | |
| M0017730ME | | S214105712S |
| M0017731ME | | S214105712S |

Important: The information contained in this bulletin is intended for use by trained, professional technicians who have the proper tools, equipment, and training to perform the required maintenance described above. This information is NOT intended for 'do-it-yourselfers', and you should not assume that this information applies to your equipment. If you have any questions regarding this information please visit our website at www.prestolite.com, or contact our technical service department at:

| | | |
|--------|----------------------------|---|
| Group: | ME Starters | Notes: Refer to SP1012 for parts breakdown. Refer to TSB-3010 for hardware kit breakdown. |
| Form: | SP1012-DWG | |
| Date: | July 7, 2017 | |
| File: | Starter Parts List Section | |

ME Series Starter Motors

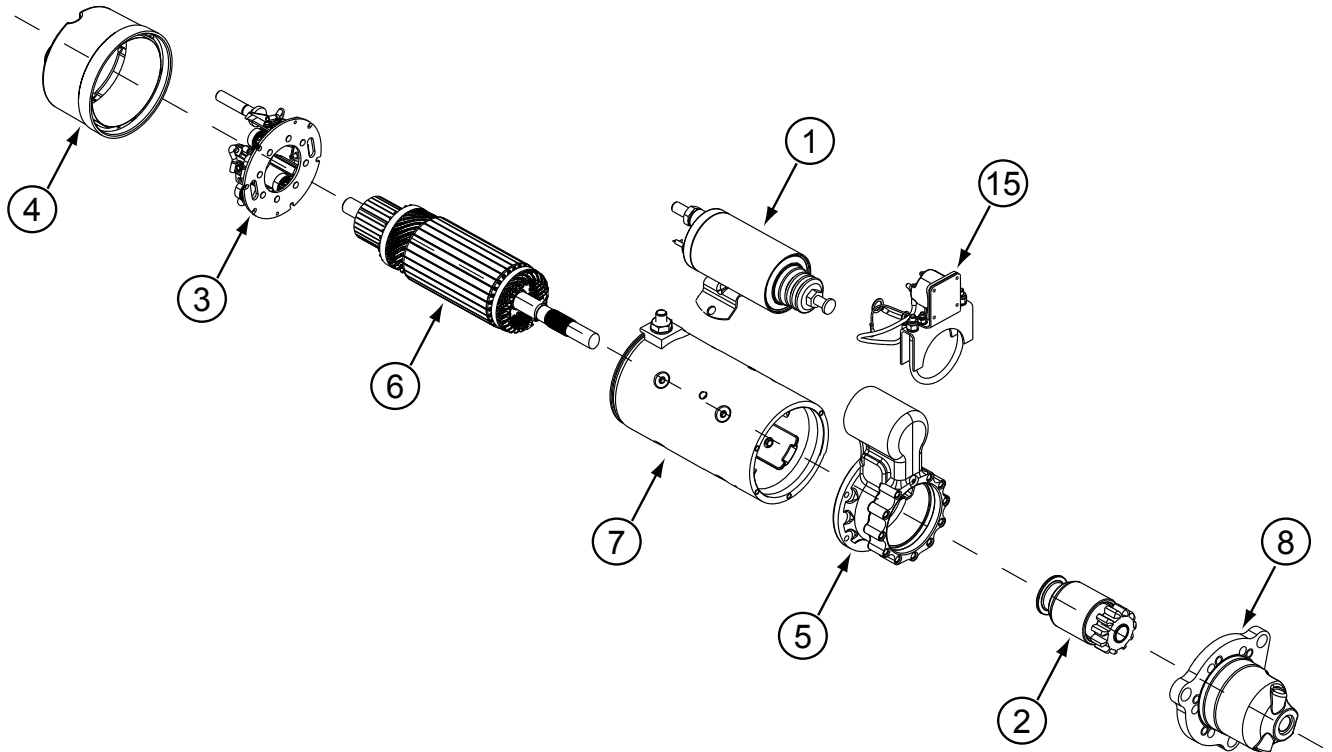

See TSB-3010
for Hardware Kit
breakdown

Important: The information contained in this bulletin is intended for use by trained, professional technicians who have the proper tools, equipment, and training to perform the required maintenance described above. This information is NOT intended for 'do-it-yourselfers', and you should not assume that this information applies to your equipment. If you have any questions regarding this information please visit our website at www.prestolite.com, or contact our technical service department at:

Source: Leece-Neville Heavy Duty Systems Division - Arcade, NY USA
Date: JULY 7, 2017
Bulletin No: TSB-3010
Models: M-Series Starter Motors
Subject: Hardware Kit for M-Series Starter Motors K212104624S

NOTE: All of these components are part of the hardware kit and not available for individual purchase.

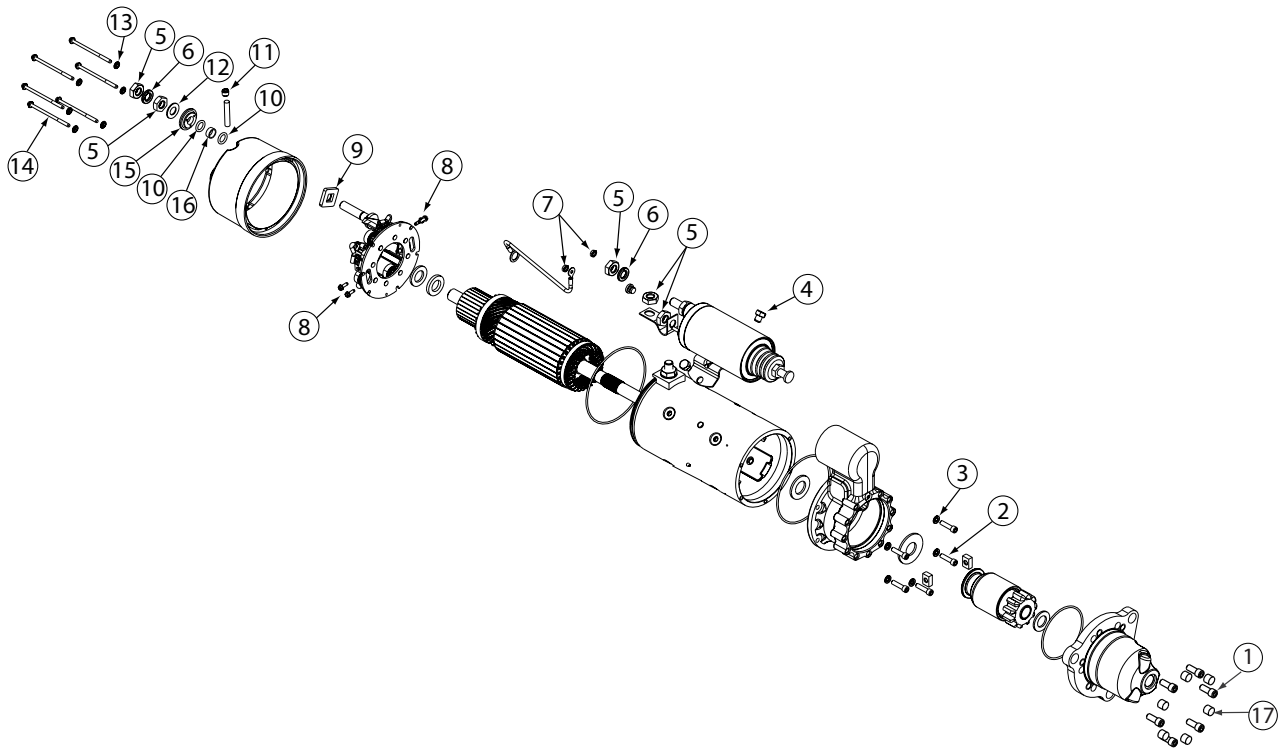

Important: The information contained in this bulletin is intended for use by trained, professional technicians who have the proper tools, equipment, and training to perform the required maintenance described above. This information is NOT intended for 'do-it-yourselfers'; and you should not assume that this information applies to your equipment. If you have any questions regarding this information please visit our website at www.prestolite.com, or contact our technical service department at:

Date: JULY 7, 2017

Bulletin No: TSB-3010

Note: All of these components are part of the hardware kit and not available for individual purchase.

| Description | QTY | Key | Where Used |
|----------------------------|-----|-----|--|
| SCREW, 5/16-18 SOCKET HEAD | 6 | 1 | Holds nose to shift lever hsg |
| SCREW, 1/4 X 1 SOC HD CAP | 5 | 2 | Holds shift lever hsg to motor |
| WASHER, LOCK 1/4 | 5 | 3 | Lock washer for item 2 |
| SCREW, 3/8-24 X 3/8 | 2 | 4 | Holds solenoid to motor |
| NUT, 1/2-13 UNC | 5 | 5 | Nuts for solenoid and motor terminals |
| NUT, 1/2-13 UNC | 2 | 5 | Used on positive and negative studs. Stainless |
| NUT, 1/2-13 UNC | 2 | 5 | Nuts for solenoid and motor terminals. Stainless |
| WASHER, LOCK 1/2 | 2 | 6 | Used on solenoid positive stud |
| LOCKNUT, #10-32 | 2 | 7 | Holds jumper wire to solenoid |
| LOCKNUT, #10-32 | 2 | 7 | Holds jumper wire to solenoid. Stainless |
| SCREW TAP #10-32 | 4 | 8 | Holds brush to brush plate |
| INSULATOR | 1 | 9 | Negative stud insulator |
| O-RING | 2 | 10 | Negative stud seal |
| PLUG, PIPE | 1 | 11 | Holds comm hsg wick in comm hsg |
| WASHER GUARD 1/2 | 1 | 12 | Negative stud hardware |
| WASHER, SEALING | 6 | 13 | Comm bolt sealing washer |
| BOLT, #10 X3.28 | 6 | 14 | Holds comm hsg to motor |
| INSULATOR | 1 | 15 | Negative stud insulator |
| BUSHING INSULATION | 1 | 16 | Negative stud insulator |
| NOSE HOUSING PLUGS | 6 | 17 | Nose housing |
| 5/16-18 BUTTON HEAD SCREW | 1 | N/A | Shift lever hsg. hardware |
| O-RING | 1 | N/A | Shift lever hsg. hardware |

Important: The information contained in this bulletin is intended for use by trained, professional technicians who have the proper tools, equipment, and training to perform the required maintenance described above. This information is NOT intended for 'do-it-yourselfers'; and you should not assume that this information applies to your equipment. If you have any questions regarding this information please visit our website at www.prestolite.com, or contact our technical service department at: