





Group:	MS2	Notes: Refer to SP1007 -DWG for major component drawing. Refer to TSB-3004 for hardware kit breakdown.
Form:	SP1007	
Date:	July 7, 2017	
File:	Starter Motor Parts List Section	

Component View	Drive Assembly	Solenoid Assembly	Brushholder Assembly	C.E. Housing Assembly	Shift Housing Assembly
					
Model	1	2	3	4	5
MS2-500	852959	6512-264	6512-265	6512-175A	M777103311S
MS2-500D	852959	6512-264	6512-265	6512-175A	M777103311S
MS2-500ND	852959	6512-264	6512-265	6512-175A	M777103311S
MS2-501	852959	6512-264	6512-245	6512-77	M777103311S
MS2-501D	852959	6512-264	6512-245	6512-77	M777103311S
MS2-501ND	852959	6512-264	6512-245	6512-77	M777103311S
MS2-502	852959	6512-264	6512-245	6512-77	M777103311S
MS2-502D	852959	6512-264	6512-245	6512-77	M777103311S
MS2-503	852959	6512-264	6512-245	6512-77	M777103311S
MS2-503D	852959	6512-264	6512-245	6512-77	M777103311S
MS2-503ND	852959	6512-264	6512-245	6512-77	M777103311S
MS2-504	852959	6512-264	6512-265	6512-175A	M777103311S
MS2-504D	852959	6512-264	6512-265	6512-175A	M777103311S
MS2-504ND	852959	6512-264	6512-265	6512-175A	M777103311S
MS2-506	852957	6512-264	6512-245	6512-77	M777103311S
MS2-506D	852957	6512-264	6512-245	6512-77	M777103311S
MS2-506ND	852957	6512-264	6512-245	6512-77	M777103311S
MS2-508	852957	6512-264	6512-245	6512-77	N/A
MS2-508D	852957	6512-264	6512-245	6512-77	N/A
MS2-508ND	852957	6512-264	6512-245	6512-77	N/A

Important: The information contained in this bulletin is intended for use by trained, professional technicians who have the proper tools, equipment, and training to perform the required maintenance described above. This information is NOT intended for 'do-it-yourselfers', and you should not assume that this information applies to your equipment. If you have any questions regarding this information please visit our website at www.prestolite.com, or contact our technical service department at:

Group:	MS2	Notes: Refer to SP1007 -DWG for major component drawing. Refer to TSB-3004 for hardware kit breakdown.
Form:	SP1007	
Date:	July 7, 2017	
File:	Starter Motor Parts List Section	



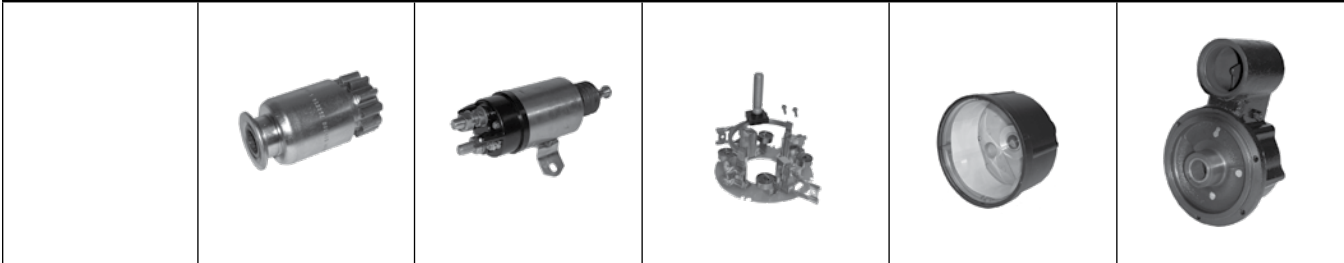

Component View	Drive Assembly	Solenoid Assembly	Brushholder Assembly	C.E. Housing Assembly	Shift Housing Assembly
----------------	----------------	-------------------	----------------------	-----------------------	------------------------



Model	1	2	3	4	5
MS2-509	852957	6512-264	6512-265	6512-175A	N/A
MS2-509D	852957	6512-264	6512-265	6512-175A	N/A
MS2-510	852959	6512-264	6512-265	6512-175A	M777103327S
MS2-510D	852959	6512-264	6512-265	6512-175A	M777103327S
MS2-510NC	852959	6512-264	6512-265	6512-175A	M777103327S
MS2-510ND	852959	6512-264	6512-265	6512-175A	M777103327S
MS2-511	852959	6512-264	6512-245	6512-77	M777103327S
MS2-511D	852959	6512-264	6512-245	6512-77	M777103327S
MS2-511NC	852959	6512-264	6512-245	6512-77	M777103327S
MS2-511ND	852959	6512-264	6512-245	6512-77	M777103327S
MS2-514	852959	6512-264	6512-245	6512-77	M777103311S
MS2-514D	852959	6512-264	6512-245	6512-77	M777103311S
MS2-514ND	852959	6512-264	6512-245	6512-77	M777103311S
MS2-520	852957	6512-264	6512-245A	6512-77	M777103348S
MS2-521	852957	6512-264	6512-245A	6512-77	M777103348S
MS2-522NCP	M029103388S	6512-264	6512-245	6512-77	M777103311S
MS2-530	852957	6512-264	6512-245	6512-77	M777103311S
MS2-530D	852957	6512-264	6512-245	6512-77	M777103311S
MS2-530ND	852957	6512-264	6512-245	6512-77	M777103311S
MS2-531	852957	6512-264	6512-265	6512-175A	M777103311S
MS2-531D	852957	6512-264	6512-265	6512-175A	M777103311S
MS2-531N	852957	6512-264	6512-265	6512-175A	M777103311S
MS2-531ND	852957	6512-264	6512-265	6512-175A	M777103311S
MS2-570	852957	6512-264	6512-245A	6512-77	M777103311S
MS2-570D	852957	6512-264	6512-245A	6512-77	M777103311S
MS2-570ND	852957	6512-264	6512-245A	6512-77	M777103311S
MS2-571	852957	6512-264	6512-265A	6512-175A	M777103311S
MS2-571D	852957	6512-264	6512-265A	6512-175A	M777103311S
MS2-571ND	852957	6512-264	6512-265A	6512-175A	M777103311S





Important: The information contained in this bulletin is intended for use by trained, professional technicians who have the proper tools, equipment, and training to perform the required maintenance described above. This information is NOT intended for 'do-it-yourselfers', and you should not assume that this information applies to your equipment. If you have any questions regarding this information please visit our website at www.prestolite.com, or contact our technical service department at:

Group:	MS2	Notes: Refer to SP1007 -DWG for major component drawing. Refer to TSB-3004 for hardware kit breakdown.
Form:	SP1007	
Date:	July 7, 2017	
File:	Starter Motor Parts List Section	

Component View	Field and Frame Assembly	Nose Housing Assembly	Hardware Assembly	Brushes Kit	Jumper
					
Model	7	8	9	10	
MS2-500	6512-238	M014103922S	K212103986S	K185104685S	859775
MS2-500D	6512-238	M014103922S	K212103986S	K185104685S	859775
MS2-500ND	6512-238	M014103922S	K212103986S	K185104685S	859775
MS2-501	6512-238	M014103922S	K212103986S	K185104685S	859775
MS2-501D	6512-238	M014103922S	K212103986S	K185104685S	859775
MS2-501ND	6512-238	M014103922S	K212103986S	K185104685S	859775
MS2-502	6512-238	M014103913S	K212103986S	K185104685S	859775
MS2-502D	6512-238	M014103913S	K212103986S	K185104685S	859775
MS2-503	6512-238	M014103913S	K212103986S	K185104685S	859775
MS2-503D	6512-238	M014103913S	K212103986S	K185104685S	859775
MS2-503ND	6512-238	M014103913S	K212103986S	K185104685S	859775
MS2-504	6512-238	M014103913S	K212103986S	K185104685S	859775
MS2-504D	6512-238	M014103913S	K212103986S	K185104685S	859775
MS2-504ND	6512-238	M014103913S	K212103986S	K185104685S	859775
MS2-506	6512-238	M014103913S	K212103986S	K185104685S	859775
MS2-506D	6512-238	M014103913S	K212103986S	K185104685S	859775
MS2-506ND	6512-238	M014103913S	K212103986S	K185104685S	859775
MS2-508	6512-238	M014103922S	K212103986S	K185104685S	859775
MS2-508D	6512-238	M014103922S	K212103986S	K185104685S	859775
MS2-508ND	6512-238	M014103922S	K212103986S	K185104685S	859775



Important: The information contained in this bulletin is intended for use by trained, professional technicians who have the proper tools, equipment, and training to perform the required maintenance described above. This information is NOT intended for 'do-it-yourselfers', and you should not assume that this information applies to your equipment. If you have any questions regarding this information please visit our website at www.prestolite.com, or contact our technical service department at:

Group:	MS2	Notes: Refer to SP1007 -DWG for major component drawing. Refer to TSB-3004 for hardware kit breakdown.
Form:	SP1007	
Date:	July 7, 2017	
File:	Starter Motor Parts List Section	

Component View	Field and Frame Assembly	Nose Housing Assembly	Hardware Assembly	Brushes Kit	Jumper
					
Model	7	8	9	10	11
MS2-509	6512-238	M014103922S	K212103986S	K185104685S	859775
MS2-509D	6512-238	M014103922S	K212103986S	K185104685S	859775
MS2-510	6512-238	M014103909S	K212103986S	K185104685S	859775
MS2-510D	6512-238	M014103909S	K212103986S	K185104685S	859775
MS2-510NC	6512-238	M014103909S	K212103986S	K185104685S	859775
MS2-510ND	6512-238	M014103909S	K212103986S	K185104685S	859775
MS2-511	6512-238	M014103909S	K212103986S	K185104685S	859775
MS2-511D	6512-238	M014103909S	K212103986S	K185104685S	859775
MS2-511NC	6512-238	M014103909S	K212103986S	K185104685S	859775
MS2-511ND	6512-238	M014103909S	K212103986S	K185104685S	859775
MS2-514	6512-238	M014103913S	K212103986S	K185104685S	859775
MS2-514D	6512-238	M014103913S	K212103986S	K185104685S	859775
MS2-514ND	6512-238	M014103913S	K212103986S	K185104685S	859775
MS2-520	6512-238	M014103943S	K212103986S	K185104685S	859775
MS2-521	6512-238	M014103352S	K212103986S	K185104685S	859775
MS2-522NCP	6512-238	N/A	K212103986S	K185104685S	859775
MS2-530	6512-238	N/A	K212103986S	K185104685S	859775
MS2-530D	6512-238	N/A	K212103986S	K185104685S	859775
MS2-530ND	6512-238	N/A	K212103986S	K185104685S	859775
MS2-531	6512-238	N/A	K212103986S	K185104685S	859775
MS2-531D	6512-238	N/A	K212103986S	K185104685S	859775
MS2-531N	6512-238	N/A	K212103986S	K185104685S	859775
MS2-531ND	6512-238	N/A	K212103986S	K185104685S	859775
MS2-570	6512-238	N/A	K212103986S	K185104685S	859775
MS2-570D	6512-238	N/A	K212103986S	K185104685S	859775
MS2-570ND	6512-238	N/A	K212103986S	K185104685S	859775
MS2-571	6512-238	N/A	K212103986S	K185104685S	859775
MS2-571D	6512-238	N/A	K212103986S	K185104685S	859775
MS2-571ND	6512-238	N/A	K212103986S	K185104685S	859775



Important: The information contained in this bulletin is intended for use by trained, professional technicians who have the proper tools, equipment, and training to perform the required maintenance described above. This information is NOT intended for 'do-it-yourselfers', and you should not assume that this information applies to your equipment. If you have any questions regarding this information please visit our website at www.prestolite.com, or contact our technical service department at:

Group:	MS2	Notes: Refer to SP1007 -DWG for major component drawing. Refer to TSB-3004 for hardware kit breakdown.
Form:	SP1007	
Date:	July 7, 2017	
File:	Starter Motor Parts List Section	

Component View	Thrust Washer Kit	OCP	Shift Lever Kit
			
Model			
MS2-500	K185104687S	6512-88	K185104686S
MS2-500D	K185104687S	6512-88	K185104686S
MS2-500ND	K185104687S	6512-88	K185104686S
MS2-501	K185104687S	N/A	K185104686S
MS2-501D	K185104687S	N/A	K185104686S
MS2-501ND	K185104687S	N/A	K185104686S
MS2-502	K185104687S	N/A	K185104686S
MS2-502D	K185104687S	N/A	K185104686S
MS2-503	K185104687S	N/A	K185104686S
MS2-503D	K185104687S	N/A	K185104686S
MS2-503ND	K185104687S	N/A	K185104686S
MS2-504	K185104687S	6512-88	K185104686S
MS2-504D	K185104687S	6512-88	K185104686S
MS2-504ND	K185104687S	6512-88	K185104686S
MS2-506	K185104687S	N/A	K185104686S
MS2-506D	K185104687S	N/A	K185104686S
MS2-506ND	K185104687S	N/A	K185104686S
MS2-508	K185104687S	N/A	K185104686S
MS2-508D	K185104687S	N/A	K185104686S
MS2-508ND	K185104687S	N/A	K185104686S

Important: The information contained in this bulletin is intended for use by trained, professional technicians who have the proper tools, equipment, and training to perform the required maintenance described above. This information is NOT intended for 'do-it-yourselfers', and you should not assume that this information applies to your equipment. If you have any questions regarding this information please visit our website at www.prestolite.com, or contact our technical service department at:

Group:	MS2	Notes: Refer to SP1007 -DWG for major component drawing. Refer to TSB-3004 for hardware kit breakdown.
Form:	SP1007	
Date:	July 7, 2017	
File:	Starter Motor Parts List Section	

Component View	Thrust Washer Kit	OCP	Shift Lever Kit
			
Model			
MS2-509	K185104687S	6512-88	K185104686S
MS2-509D	K185104687S	6512-88	K185104686S
MS2-510	K185104687S	6512-88	K185104686S
MS2-510D	K185104687S	6512-88	K185104686S
MS2-510NC	K185104687S	6512-88	K185104686S
MS2-510ND	K185104687S	6512-88	K185104686S
MS2-511	K185104687S	N/A	K185104686S
MS2-511D	K185104687S	N/A	K185104686S
MS2-511NC	K185104687S	N/A	K185104686S
MS2-511ND	K185104687S	N/A	K185104686S
MS2-514	K185104687S	N/A	K185104686S
MS2-514D	K185104687S	N/A	K185104686S
MS2-514ND	K185104687S	N/A	K185104686S
MS2-520	K185104687S	N/A	K185104686S
MS2-521	K185104687S	N/A	K185104686S
MS2-522NCP	K185104687S	N/A	K185104686S
MS2-530	K185104687S	N/A	K185104686S
MS2-530D	K185104687S	N/A	K185104686S
MS2-530ND	K185104687S	N/A	K185104686S
MS2-531	K185104687S	6512-88	K185104686S
MS2-531D	K185104687S	6512-88	K185104686S
MS2-531N	K185104687S	6512-88	K185104686S
MS2-531ND	K185104687S	6512-88	K185104686S
MS2-570	K185104687S	N/A	K185104686S
MS2-570D	K185104687S	N/A	K185104686S
MS2-570ND	K185104687S	N/A	K185104686S
MS2-571	K185104687S	6512-88	K185104686S
MS2-571D	K185104687S	6512-88	K185104686S
MS2-571ND	K185104687S	6512-88	K185104686S

Important: The information contained in this bulletin is intended for use by trained, professional technicians who have the proper tools, equipment, and training to perform the required maintenance described above. This information is NOT intended for 'do-it-yourselfers', and you should not assume that this information applies to your equipment. If you have any questions regarding this information please visit our website at www.prestolite.com, or contact our technical service department at:

Group:	MS2 Starters	Notes: Refer to SP1007 for parts breakdown. Refer to TSB-3004 for hardware kit breakdown.
Form:	SP1007-DWG	
Date:	July 7, 2017	
File:	Starter Parts List Section	

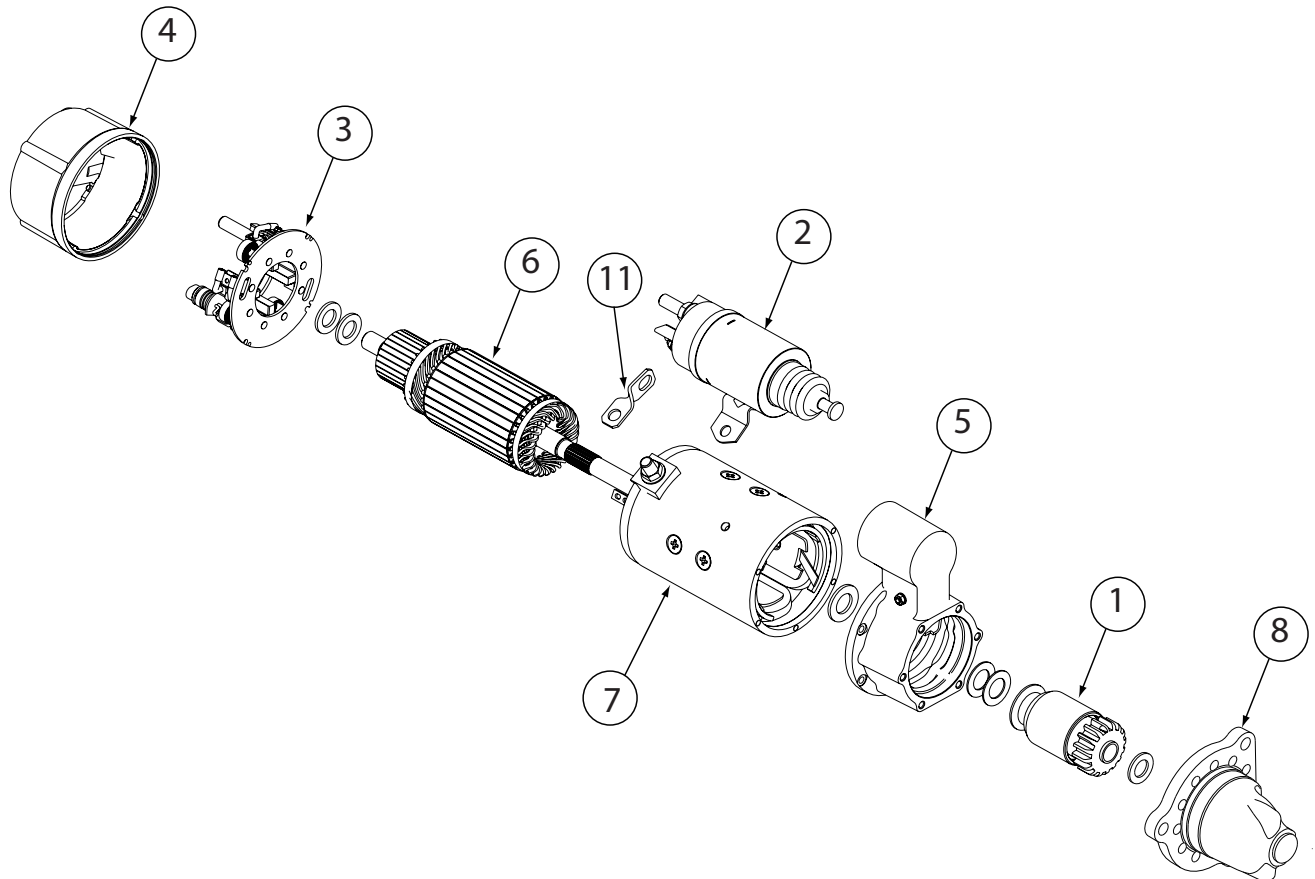

See TSB-3004
for Hardware Kit
breakdown

Important: The information contained in this bulletin is intended for use by trained, professional technicians who have the proper tools, equipment, and training to perform the required maintenance described above. This information is NOT intended for 'do-it-yourselfers', and you should not assume that this information applies to your equipment. If you have any questions regarding this information please visit our website at www.prestolite.com, or contact our technical service department at:

Source: Leece-Neville Heavy Duty Systems Division - Arcade, NY USA
Date: JULY 7, 2017
Bulletin No: TSB-3004
Models: MS2 series starter motors
Subject: Hardware service kits

NOTE: All of these components are part of the hardware kit and not available for individual purchase.

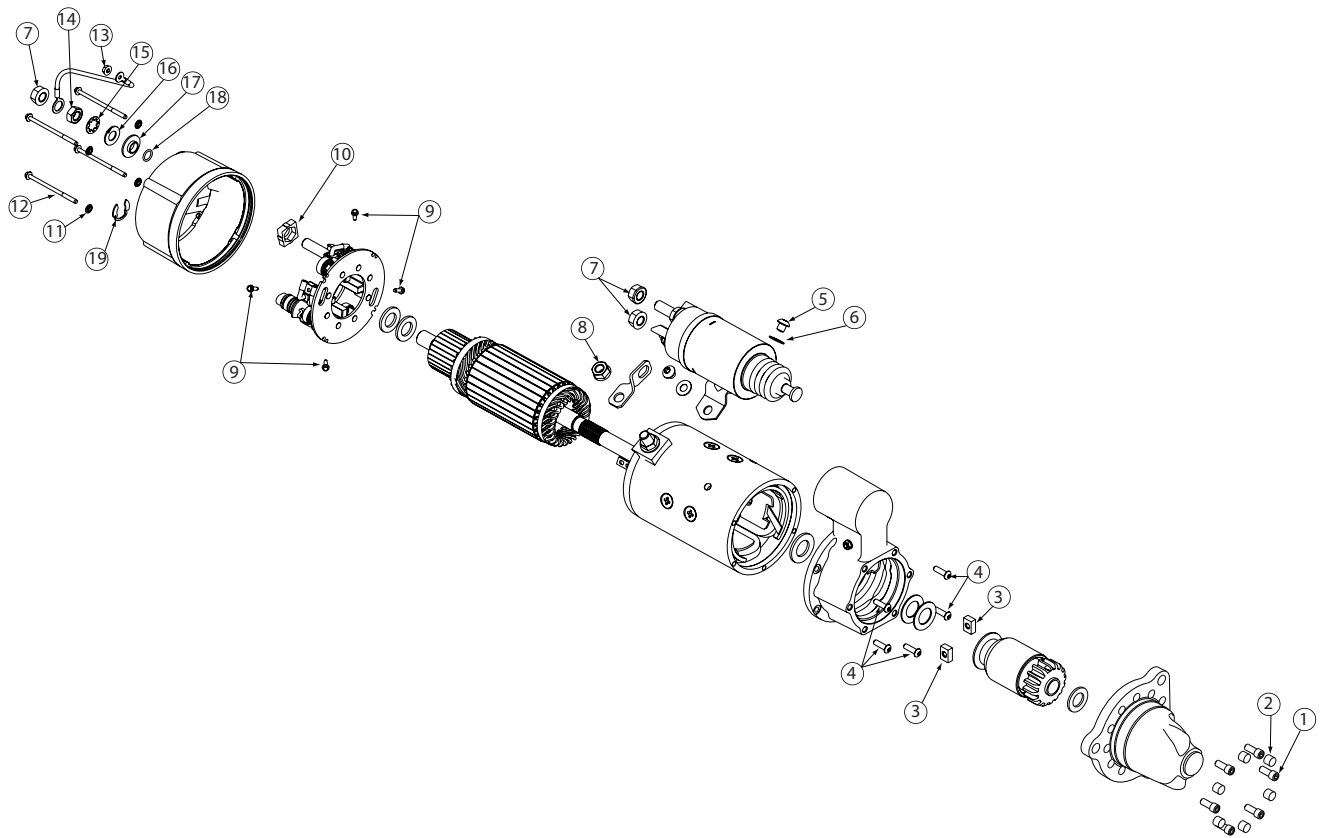

Important: The information contained in this bulletin is intended for use by trained, professional technicians who have the proper tools, equipment, and training to perform the required maintenance described above. This information is NOT intended for 'do-it-yourselfers'; and you should not assume that this information applies to your equipment. If you have any questions regarding this information please visit our website at www.prestolite.com, or contact our technical service department at:

Date: JULY 7, 2017

Bulletin No: TSB-3004

Note: All of these components are part of the hardware kit and not available for individual purchase.

Description	Key	Qty	Where Used
Soc HD Bolts	1	6	Hold nose housing to shift lever hsg
Rubber Plugs	2	6	Nose housing plugs
Cam, Lever Arm	3	2	Moves drive on shaft
Screw, Button HD	4	5	Attach shift lever Hsg to motor
Screw, Button HD	5	2	Attaches solenoid to motor
Washer, Flat	6	2	Flat washers for Key item 5
Nut, Hex Flange	7	3	Attaches cable to starter
Nut, Hex Flange, Metric	8	1	Attaches jumper strap to motor
Screw, Tap	9	4	Attaches brushes to brush plate
Insulator	10	1	Negative stud insulator
Washer, Sealing	11	4	Seals CE bolts to CE Hsg
Bolt, Hex, Wash	12	4	Attaches CE Hsg to motor
Nut, Hex Flange	13	1	Attaches ground wire to solenoid
Nut, Hex	14	1	Negative stud hardware
Lockwasher	15	1	Negative stud hardware
Washer, Flat	16	1	Negative stud hardware
Insulator	17	1	Insulates negative stud from CE Hsg
O-Ring	18	1	Seals negative stud in CE Hsg
Ring, Retainer	19	1	Holds OCP into CE Hsg

Important: The information contained in this bulletin is intended for use by trained, professional technicians who have the proper tools, equipment, and training to perform the required maintenance described above. This information is NOT intended for 'do-it-yourselfers', and you should not assume that this information applies to your equipment. If you have any questions regarding this information please visit our website at www.prestolite.com, or contact our technical service department at: