

VLF2276-001, Front

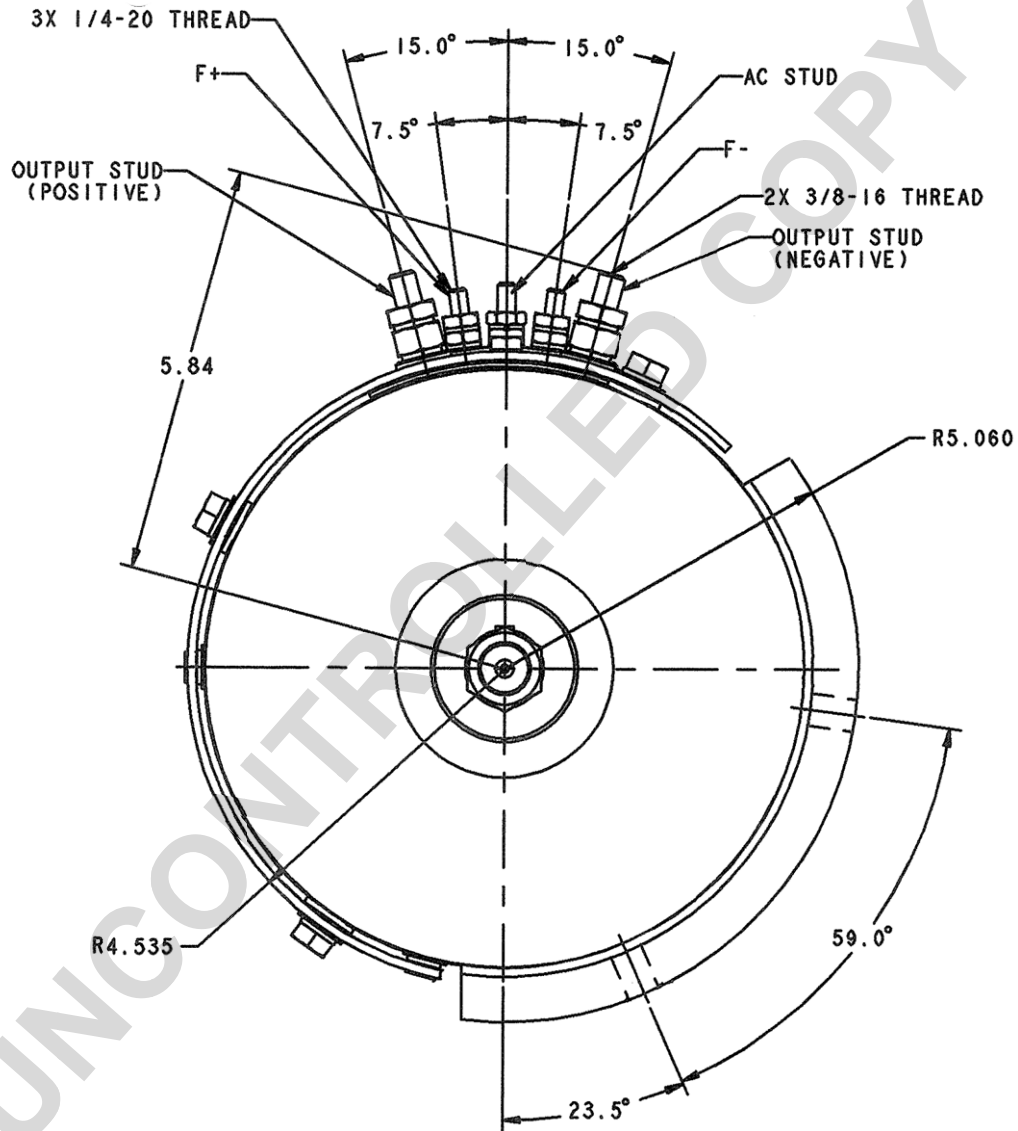

NOTICE - PRESTOLITE CLAIMS PROPRIETARY RIGHTS IN THE INFORMATION DISCLOSED ON THIS DRAWING. IT IS ISSUED IN CONFIDENCE FOR ENGINEERING INFORMATION ONLY AND MAY NOT BE USED, IN WHOLE OR IN PART, TO MANUFACTURE ANYTHING, WHETHER OR NOT SHOWN HEREON, REPRODUCED OR DISCLOSED TO ANYONE WITHOUT DIRECT WRITTEN PERMISSION FROM PRESTOLITE.

USE OR DISCLOSURE OF DATA ON THIS SHEET IS SUBJECT TO THE RESTRICTION CLAUSE FAR 52.215-1.